

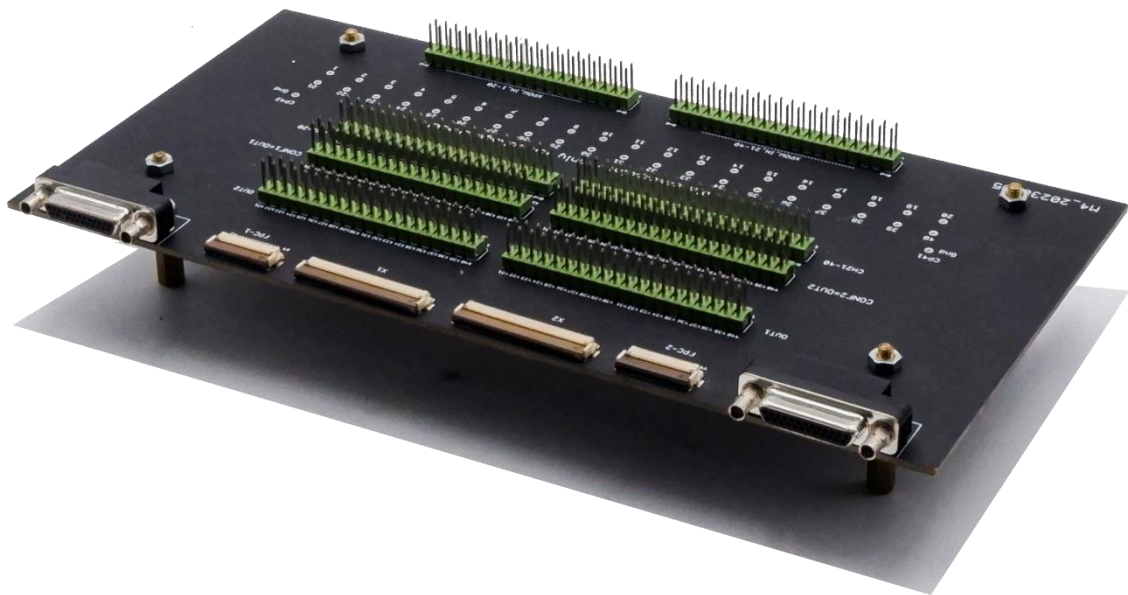

M4 Specification

January 2025



Version: 3.2

Date: 9 January 2025

Important Notice and Disclaimer:

No part of this document may be reproduced in any form or by any means (including electronic storage and retrieval or translation into a foreign language) without prior agreement and written consent from Nicslab. No responsibility is assumed by Nicslab for its use, nor for any infringements of patents or other rights of third parties that may result from its use. Trademarks and registered trademarks are the property of their respective owners.

This product is designated for skilled user. You are entirely responsible for (1) choosing the appropriate Nicslab products for your operation, (2) designing, validating and testing your operation, (3) ensuring your operation meets applicable standards, and any other safety, security or other requirements.

Copyright © 2025, Nicslab.

Safety Note

Do not operate this product in any manner not specified by Nicslab. Failure to comply with these precautions or with specific warnings or instructions elsewhere in this manual violates safety standards of design, manufacture, and intended use of the instrument. Nicslab assumes no responsibility for any damage caused by mishandling that is beyond normal usage defined in this manual of this product.

Before Applying DC Power Supply

Verify that the DC power supply is good condition and safe to use. It is imperative to use ONE DC power supply as a source power for this product and the input voltage is no more than 36 V, or it can impair this product. Make all connections to the unit before applying power.

Do Not Discard the Instrument Cover

Only authorized personnel from Nicslab should remove the instrument cover.

Do Not Alter the Instrument

Do not put any unauthorized parts or modify the instrument without Nicslab approval and warranty.

Caution

This symbol indicates the hazard of any operating procedure, practice, or the like that, if not correctly performed or adhered to, could result in damage to the product or loss of important data.

Contents

List of Tables	3
List of Figures	3
1. Multi-connectors Details	4
Hardware Configuration	4
Hardware Installation	7
2. Company Policy	8
3. Contact	9

List of Tables

Table 1. M4 - Multi-Connector point information	5
---	---

List of Figures

Figure 1. M4 – Multi-Connector configuration - 1	4
Figure 2. M4 – Multi-Connector configuration - 2	5
Figure 3. M4 - Callout A	6
Figure 4. M4 - Callout B	6
Figure 5. M4 - Callout C	6
Figure 6. M4 - Callout D	6
Figure 7. Multi-connectors testing configuration	7

1. Multi-connectors Details

Multi-connector for XPOW is designed to have the flexibility and reconfigurability of the main system. There are several versions of multi-connector. Please check your multi-connector version.

Hardware Configuration

M4 multi-connector consist of several different types of connectors including FFC, D-sub25, and 2.54 mm pin output. It is suitable for applications that required multiple devices with different connections.

M4

Dimension : 10 (L) x 20 (W) x 1.2 (H) cm

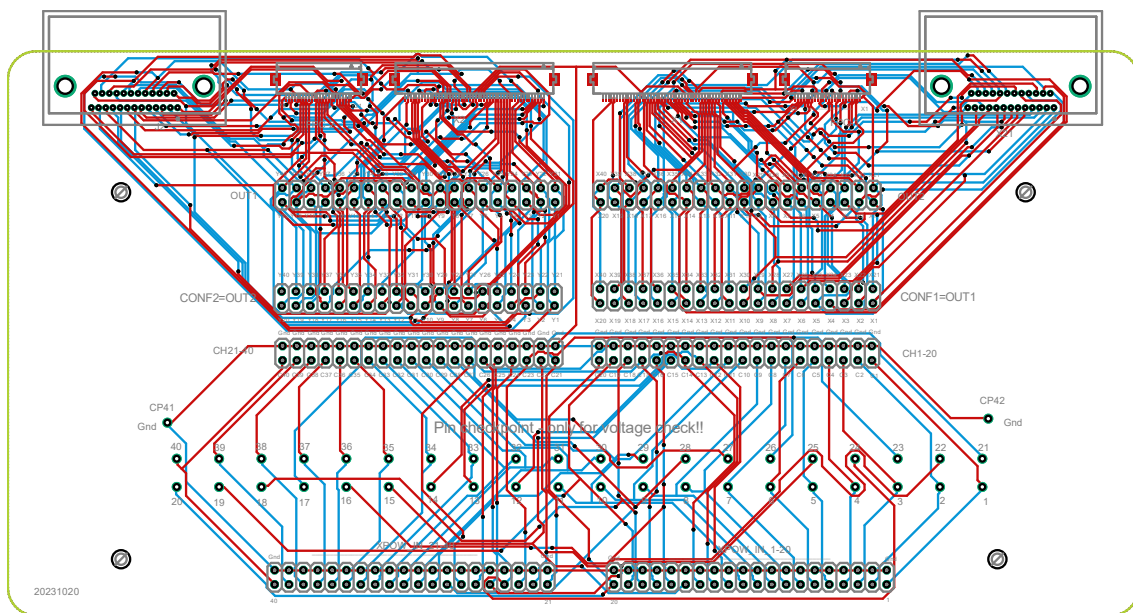

Figure 1. M4 – Multi-Connector configuration - 1

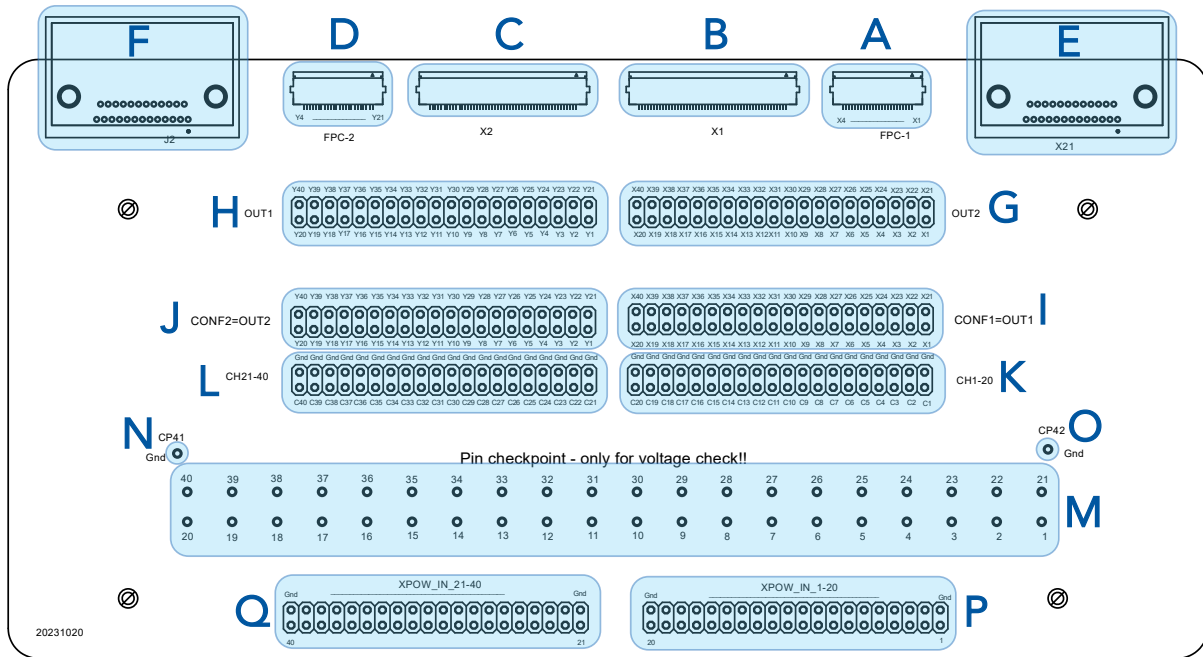

Figure 2. M4 – Multi-Connector configuration - 2

Below is an explanation of each point in the multi connector configuration from A to Q:

Table 1. M4 - Multi-Connector point information

Callout	Component Description
A	FFC-1 24 pin (X1-X4, X21-X40)
B	FFC X-1 50 pin (X21-X40, X1-X20)
C	FFC X-2 50 pin (Y21-Y40, Y1-Y20)
D	FFC-2 24 pin (Y1-Y4, Y35-Y40, Y34-Y21)
E	Micro-D Connector (MH1, MH2, X1-X5, X21-X40)
F	Micro-D Connector (MH1, MH2, Y1-Y5, Y21-Y40)
G	2x20-1 pin header 2.54 mm (X1 – X40)
H	2x20-2 pin header 2.54 mm (Y1 – Y40)
I	CONF 2x20-1 pin header 2.54 mm (X1 – X40)
J	CONF 2x20-2 pin header 2.54 mm (Y1 – Y40)
K	2x20-5 pin header 2.54 mm ((C1 – C20) + GND)
L	2x20-5 pin header 2.54 mm ((C21 – C40) + GND)
M	Channel 1-40 output check point pin (1 - 40)
N	GND check point 1 pin (41)
O	GND check point 2 pin (42)
P	1 -20 CH in 2x20-7 pin header 2.54 mm (1 – 20)
Q	21 – 40 CH in pin header 2.54 mm (21 – 40)

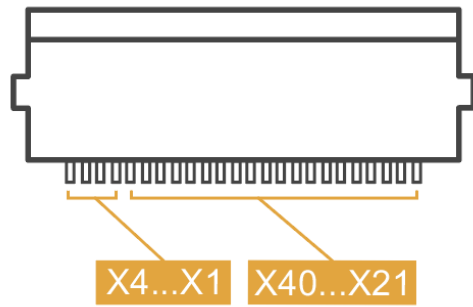

Figure 3. M4 - Callout A

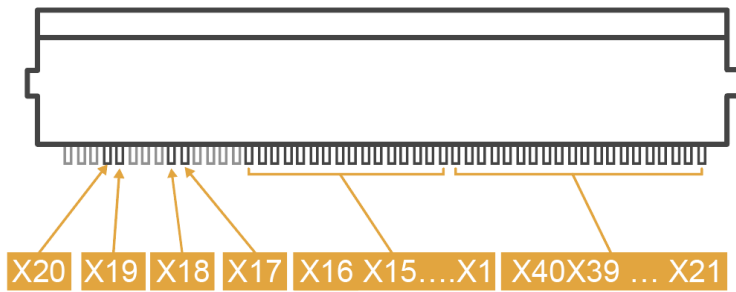

Figure 4. M4 - Callout B

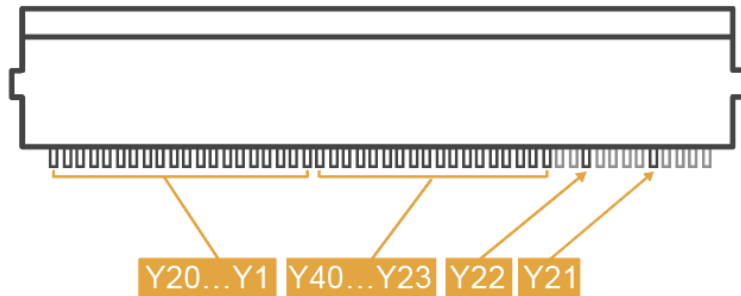

Figure 5. M4 - Callout C

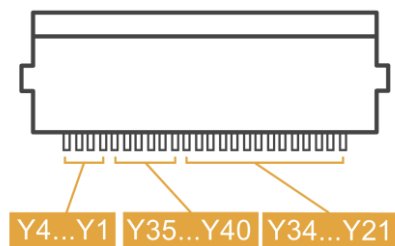
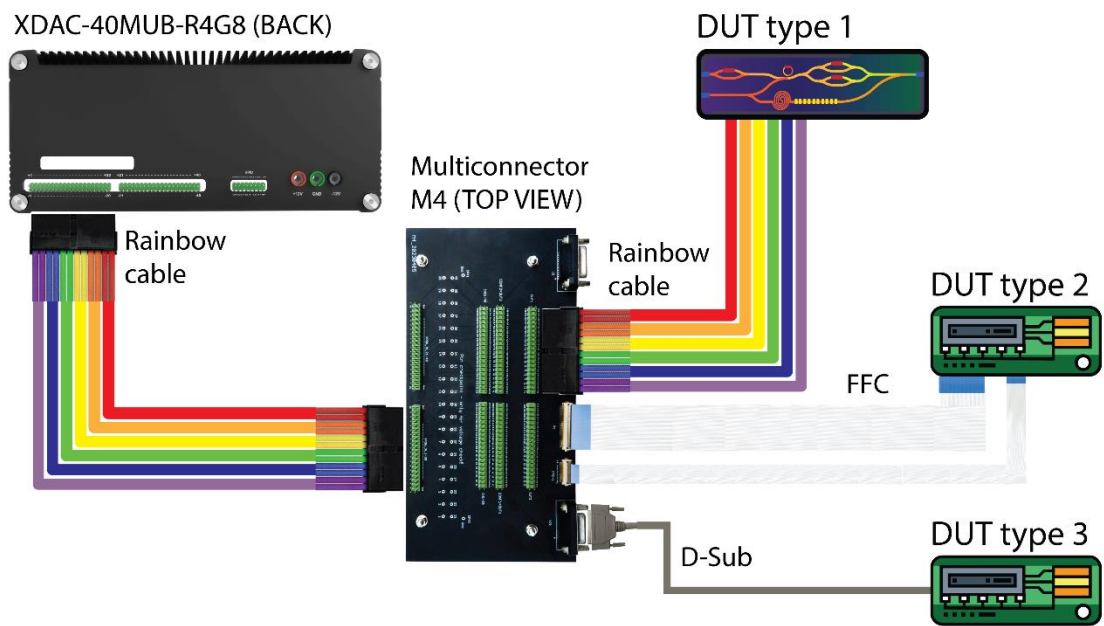

Figure 6. M4 - Callout D

Hardware Installation

Example on how to configure multi-connectors to test the device:



DUT = Device under test

Figure 7. Multi-connectors testing configuration

2. Company Policy

Warranty – We guarantee to provide accurate descriptions and a high-quality product. Please do not hesitate to contact us at support@nicslab.com if you would like to have more information. If you have any problems with your order, please notify us within 60 days from the date of shipment of any defects. You agree to pay for the return shipping on exchanges and returns and we will reimburse this cost upon verification of a defect with the product. Moreover, a warranty will not apply if the product has been subject to misuse, neglect, accident, modification, or has been soldered or altered in any way.

Return and refund policy – If you are not happy with the product you purchased, for any reason, it is possible to return it for a refund within 5 days of receipt (10 days for an exchange).

Please advise us by email: support@nicslab.com for return authorization.

- Return for refund: within 5 days of receiving your product. (unopened)
- Return for replacement: within 10 days of receiving your product. (damaged or defective)

Please note that no return will be accepted without a return authorization. A return must be in its original and clean condition. Returns in a damaged, scratched or burnt condition will not be accepted. The product must be returned in its original packaging with its receipt and a small note for the reason for the return. This will help us to serve you better and improve our products. Reimbursement only applies upon the confirmation of the above-mentioned conditions.

All items will be reimbursed within 3 days of receiving the product (shipping fee excluded). You will need to pay for shipping (if you would like to have a refund instead of a replacement). We will be responsible for refund shipping fees if the return is a result of a shipping error from our side.

3. Contact

New York

Nicslab Ops, Inc.
260 E. Main St., Suite 6408
Rochester, NY 14604
United States
Phone: +1 (650) 521-9982
Email: support@nicslab.com
Website: www.nicslab.com

California

Nicslab Ops, Inc.
228 Hamilton Avenue
3rd Floor, Palo Alto
Silicon Valley, CA 94301
United States

Indonesia

PT Nicslab Global Industri
Menara Asia Afrika, Jl. Asia Afrika No.133-137
LT. 9
Kb. Pisang, Kec. Sumur Bandung
Kota Bandung, Jawa Barat 40112
Indonesia
Phone: +62 22 8602 6854
Email: nicslab.id@nicslab.com

Book a meeting [here](#).